

Long Pulse/High Power ECRF System Development in JT-60U

S. Moriyama, T. Kobayashi, A. Isayama, M. Terakado, M. Sawahata, S. Suzuki, K. Yokokura, M. Shimono, K. Hasegawa, S. Hiranai, K. Igarashi, F. Sato, T. Suzuki, K. Wada, S. Shinozaki, M. Seki, A. Kasugai, K. Takahashi, K. Kajiwara, K. Sakamoto and T. Fujii

Japan Atomic Energy Agency, Naka, Ibaraki 311-0193 Japan

e-mail contact of main author: moriyama.shinichi@jaea.go.jp

Abstract. In the recent gyrotron development in JT-60U ECRF system, output power of 1.5 MW for 1 s has been achieved at 110 GHz. It is the world highest power oscillation in the range of > 1 s. In addition to the carefully designed cavity and collector in view of thermal stress, an RF shield for the adjustment bellows, and a low-dielectric-loss DC break enabled this achievement. Power modulation technique by anode voltage control was improved to obtain high modulation frequency and 5 kHz has been achieved for NTM stabilizing experiments. Moreover as a development step to realize a reliable ECRF system in future fusion experiments, long pulse demonstration of 0.4 MW, 30 s injection to the plasma has been achieved with real time control of anode/cathode-heater. It has been confirmed that the temperature of cooled components were saturated and no evidence of damage were found in the waveguides and antenna without forced cooling. As a forced cooling antenna for longer pulse in future, an innovative antenna having relatively wide range of beam steering capability with linearly-moving-mirror concept has been designed. Beam profile and mechanical strength analyses shows the feasibility of the antenna.

1. Introduction

Electron cyclotron range of frequency (ECRF) systems are playing important and various roles in plasma experiments, e.g., electron heating, current profile control, MHD mode suppression, and plasma initiation. Most of such purposes require high power capability to the ECRF system and some of them need longer pulse duration, in accordance with extension of the duration of the high performance plasma. In JT-60U, the ECRF system started its operation in 1999, and the full system employing four 1 MW gyrotrons and two antennas completed in 2001[1]. The designed specifications were 1 MW for 5 s at 110 GHz of power output from a triode gyrotron, 80% of transmission efficiency for a matching optics unit (MOU), 60 m of $\phi 31.75$ mm corrugated waveguide and 9 miter bends. Operation with full specification was achieved for individual gyrotron and transmission line in relatively early stage, i.e., 1.5 MW for 5 sec injection in 2001 with two gyrotrons[2]. Nevertheless the total high power performance remained at 2.8 MW for 3.6 s since 2004 [3]. On the other hand, long pulse capability at lower power was improved year by year and was reached 0.35 MW for 20 s in 2006. The performance and the function of the system were improved year by year as well as pulse duration, and last two years in the last experiment campaign of JT-60U were most fruitful years for the ECRF system. This paper is focusing on the developments and achievements in the two years. Section 2 describes development of a high power gyrotron and achievement of 1.5 MW for 1 s. In section 3, improvement in long pulse capability of the gyrotron operation and performance of transmission line are shown. Development of power modulation technique up to 5-7 kHz and its application to neoclassical tearing mode (NTM) stabilization are shown in section 4, and development of antenna with high reliability for the next-stage longer-pulse experiments is described in section 5.

2. High power gyrotron development

To establish effective electron heating or current drive in fusion experiments at present and in near future, reliable and efficient ECRF system is required. Many gyrotrons have achieved 1MW oscillation, which is ITER specification, but higher power per gyrotron is effective to reduce the cost per heating power and enhance the system efficiency. From this viewpoint, development aiming at 2 MW per gyrotron is proceeding in the world but the pulse width has been remained around milliseconds. Power level of 1~1.3 MW was limitation for the range of 1 s which is effective pulse

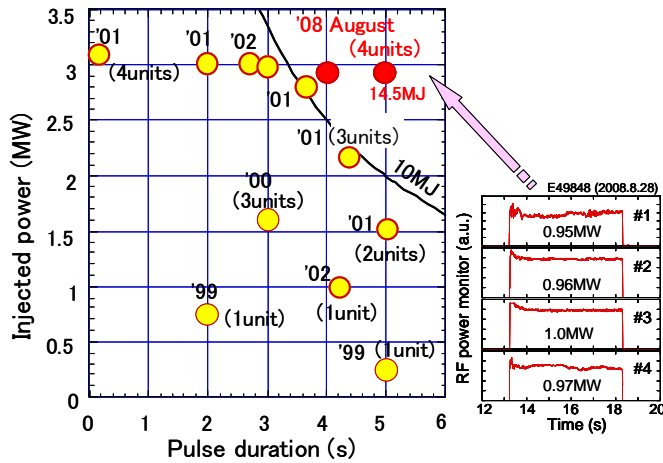

Fig. 1. Injected RF power and pulse duration of JT-60 ECRF system. Simultaneous operation of all 4 gyrotrons at 1MW for 5sec enabled 2.9 MW (14.5 MJ) injection with transmission efficiency of ~ 0.75 .

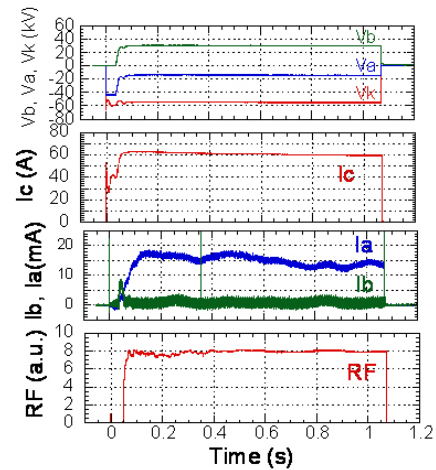

Fig. 2. Waveforms of high voltage applied to the gyrotron, current and RF signals on 1.5 MW for 1 s oscillation. The suffixes a, b, c, k stand for anode, body, collector and cathode respectively.

length for the ECRF experiments at present.

The original JT-60U ECRF system was built by 2001 with four of 1 MW, 5 s gyrotrons and injection to the plasma of 14.5 MJ (2.9 MW, 5 s) has been achieved in August 2008 as shown in Fig. 1. On the other hand, high power oscillation up to 1.5 MW for 1 s has been successfully attained with a gyrotron on the dummy load operation as shown in Fig. 2. Operation parameters are body(V_b)-cathode(V_k) (acceleration) and anode(V_a)-body(V_b) voltages of 86kV and 42.8kV respectively, and the peak beam current of 62.8A [4]. The power was measured by a water cooled dummy load system with calorimeter. As shown in Fig.3, it is the world highest power oscillation in the range of >1 s, which is well applicable duration for the ECH/ECCD experiments in the present experiments. In addition to the carefully designed cavity and collector in view of thermal stress, the gyrotron has an RF shield for the adjustment bellows of the last mirror, and a DC break between the collector and body electrode made of Si_3N_4 which has a low loss tangent and high strength for thermal stress. These technologies are common to the 170 GHz gyrotron which demonstrated 1 MW for 800 s for ITER development in JAEA [5].

The time trace of the cavity temperature was saturated below the boiling temperature ($\sim 150^\circ C$) and the temperature did not reach limitations in the operation of 1.5 MW for 1 s, so far. Figure 4 shows

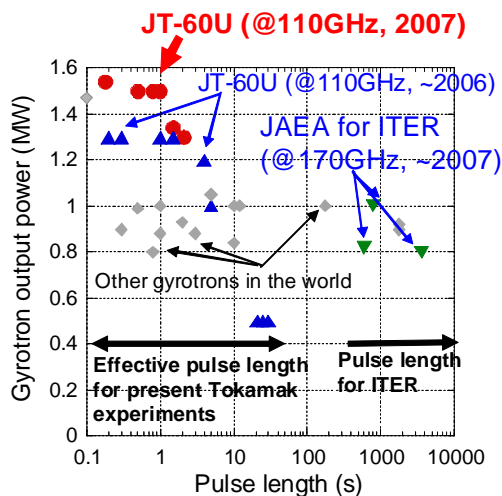

Fig. 3. Gyrotron output power achievements in the world for the pulse length of 0.1s or over.

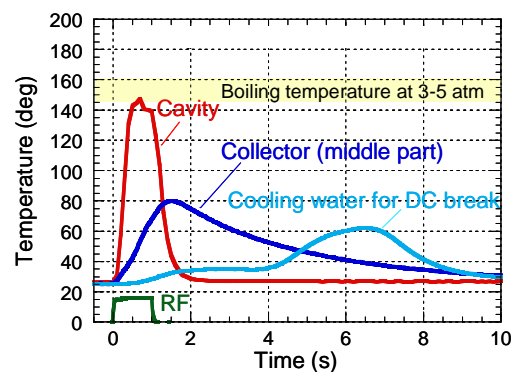

Fig. 4. Temperature of components in the gyrotron and cooling water on 1.5MW for 1s oscillation.

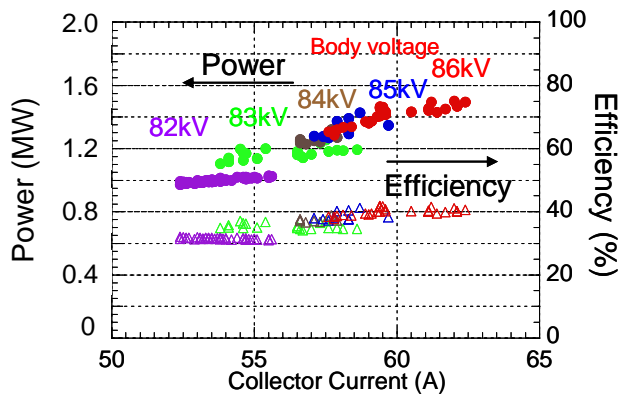

Fig. 5. Acceleration voltage and the collector current was raised carefully and gradually to obtain 1.5MW.

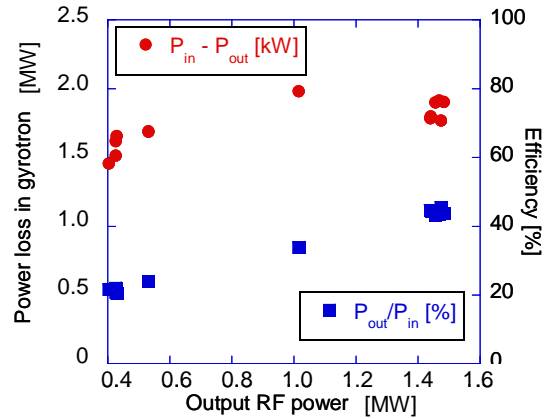

Fig.6. Gyrotron efficiency and power balance.

the measured temperature of the cavity, the collector and the cooling water for the DC break made of Si_3N_4 during and after the 1.5 MW for 1s shot. The time constant of ~ 10 s and spatial distribution of the collector temperature indicates possibility of 1.5 MW oscillations with longer duration. In the optimization of the parameters and the condition of the gyrotron, we raised the collector current and the acceleration voltage gradually and carefully as shown in Fig. 5. The efficiency of the gyrotron was raised with the output power and was reached 40% at 1.5MW including the effect of collector depression. As shown in Fig. 6, the dissipated power in the gyrotron estimated by a power balance does not vary significantly for the output RF power range from 0.4 MW to 1.5 MW. The efficiency at 0.4 – 1 MW is relatively low, partly because the oscillation was optimized for stable condition to keep high success rate of ECRF injection in JT-60U experiments with relatively large voltage ripple rate of the main power supply which was originally fabricated for Klystrons in LHRF system. Although the efficiency is low, the fact that the collector stood for the 1 MW for 5 s oscillation suggests that the collector has a potential of at least 1.5 MW for 5 s operation.

On the other hand, there is a room for improvement in the mode convertor efficiency. An RF power diffracted by a mode converter possibly yields excessive heat load on internal gyrotron components, e.g., mode converter itself and DC break, which may limit the pulse length less than 5 s. In this experiment, there is no evidence of boiling of cooling water for the mode converter or DC break though the measurement of temperature might not precisely. While gyrotron test with improved mode converter to minimize the diffraction loss has been started toward 1 MW for 100 s for JT-60SA, the improvement will also expand pulse duration at 1.5 MW.

3. Long pulse test of the ECRF system

It is important to confirm the long pulse capability not only of the gyrotron but also of the entire system, 0.5 MW, 30 s of gyrotron oscillation and 0.4 MW of injection power to the plasma has been achieved with one line as shown in Fig. 7. In this demonstration, pre-programmed control of the anode voltage and cathode-heater has been developed. It optimizes the electron pitch angle and the beam current to compensate the cathode temperature decrease due to the electron emission. The circuit diagram that enabled this control scheme is shown in Fig. 9. It was quite effective to keep the oscillation condition compensating for the predictable decay in the collector current during the long pulse oscillation. It has been confirmed that the temperature rise of cooled components was saturated at around 15 – 20 °C as shown in Fig. 8 and no damage was found in the waveguides components and antenna.

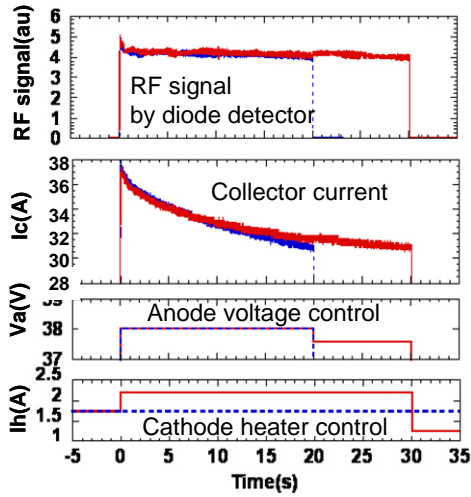

Fig. 7. Waveform of 0.4MW for 30s injection to the JT-60U plasma. Real time control of anode voltage and cathode-heater power was effective in keeping oscillation condition against the decay of collector current.

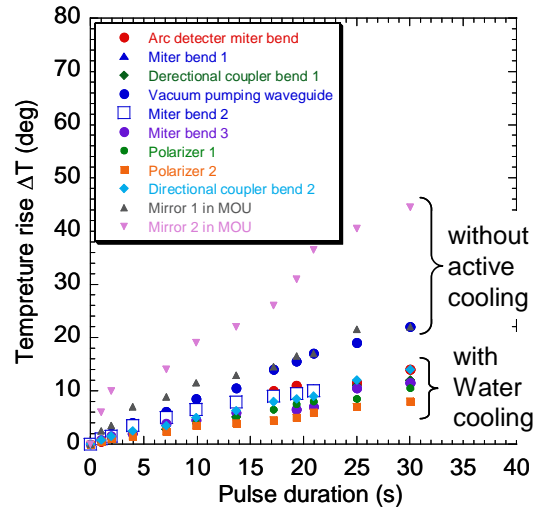

Fig. 8. Temperature rise of the each component in the transmission line. The peak of the temperature was measured during or just after the individual pulse, because thermocouple measurement has delay of a few seconds.

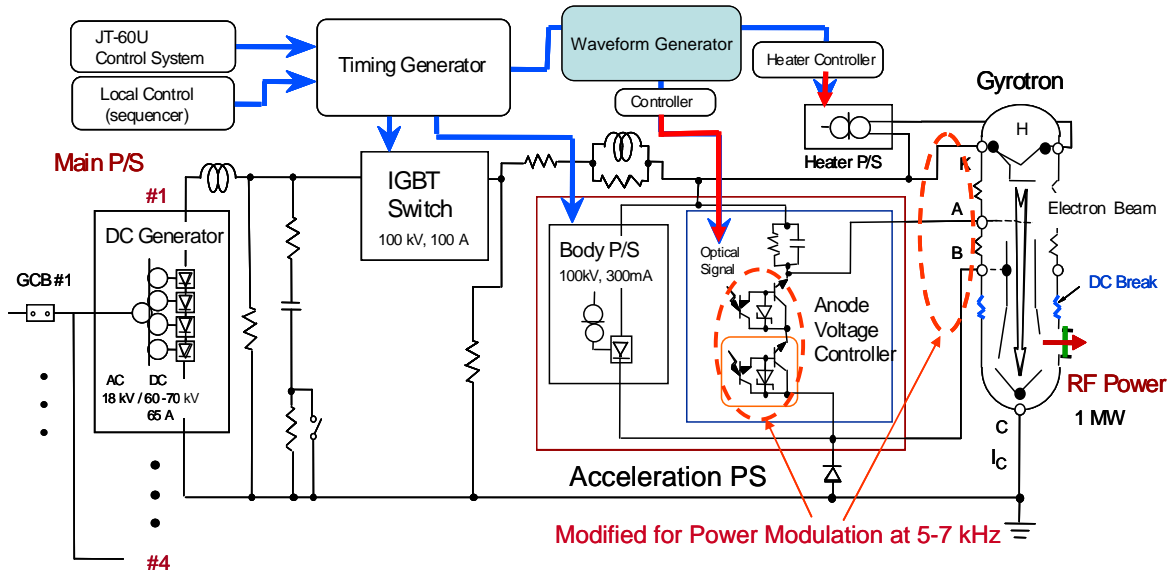

Fig. 9. Schematic diagram of power supply for long pulse gyrotron operation in JT-60U ECRF system.

4. Power modulation for stabilization of NTM

Modulation of ECRF power is useful for various experiments, e.g., stabilization of NTM, investigation of heat transport and control of edge localized mode (ELM). Since the JT-60 gyrotron is a triode having an anode with voltage control circuit as shown in Fig. 9, modulation of output power by anode voltage is relatively easy by small change in the electron pitch angle without modulating very high acceleration voltage. However it was not easy to obtain high modulating frequency. Modulation at around 0.5 kHz for heat transport experiments was achieved with the original anode voltage circuit, but some improvements were needed to obtain 5 kHz modulation for NTM stabilization. At first, the capacitance to stabilize the body voltage was reduced to lower the charging or discharging current on anode voltage change, in order to prevent over current detection.

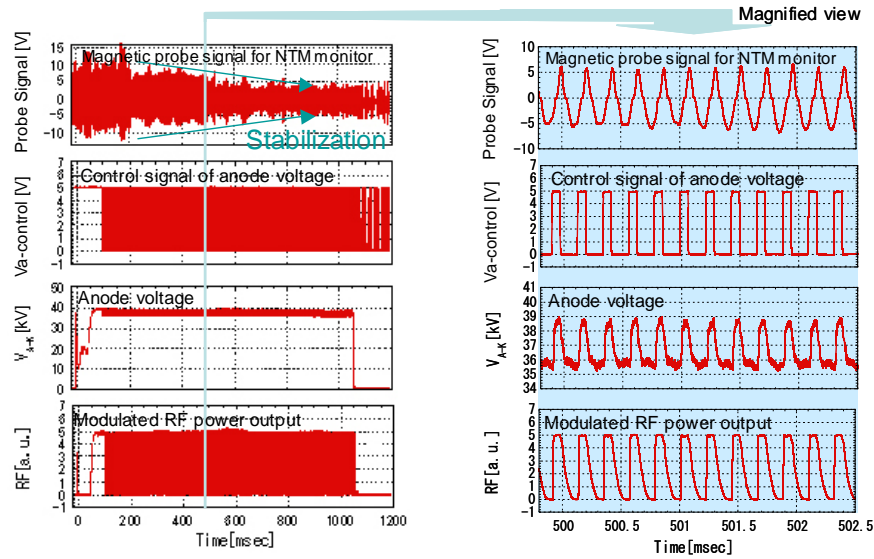

Fig. 10. Power modulation at ~ 5 kHz was achieved by controlling anode voltage for the NTM stabilization experiments. The modulation frequency and the phase was real-time-controlled referring to the magnetic probe as a reference of NTM oscillation.

The resistance of the voltage feeder was increased to prevent quick current change in the body power supply circuit. Finally the photo diode used in the anode control circuit was replaced to field-effect transistor (FET) having shorter response time. Then the modulation frequency of 7 kHz has been achieved to the dummy load and ~ 5 kHz synchronized with NTM has been injected to the plasma as shown in Fig. 10.

To synchronize with the NTM, additional function in the anode modulation control was required. Firstly because, the response of “oscillation-on” is different from “off” and varies with the beam current decay during the oscillation. Secondly because, there is a phase difference to be adjusted between the magnetic probe signal and the periodic motion of the magnetic island of the NTM. To deal with these requirements, individual waveform of anode voltage control was formed by a computer controlled function generator and the frequency of the magnetic probe signal was measured by frequency counter. The phase difference and the duty cycle were preset and the waveform of the anode control signal was automatically generated as a function of the frequency of the magnetic probe signal and time from the oscillation start to maintain the preset values. With this control scheme, 1.2 MW has been injected for 1 s with simultaneous modulation of two gyrotrons or 0.6 MW has been injected for 2 s by two gyrotrons in series, and the characteristics of NTM stabilization by modulated ECCD were investigated [6] with various choices of phasing and duty cycle.

The limitation of this modulation scheme at present is pulse duration of ~ 1 s due to anomalous heating of the mode converter by RF. This limitation may be raised by the improved mode converter which was mentioned in section 2. For higher power and CW operation with power modulation, modulation of not only anode but also acceleration (and cathode – collector) voltages may be required to reduce the collector heat load. Such development is planned for ITER gyrotron in JAEA. In that case, the similar control scheme for phase or duty cycle developed here will be applicable.

5. Conceptual study of advanced antenna with reliable steering mirrors cooled actively

In the future prospects of the longer pulse antenna, a reliable water feeder to the movable mirror will

be quite important to avoid the water leakage accident in a remote handling environment. In JT-60U, antennas featuring motor driven steerable mirror [7] brought actual results in various ECCD/ECH experiments, e.g. NTM suppression. On the basis of the experiences and achievements, two types of advanced antenna applicable to future fusion experiments, e.g. JT-60SA, ITER or SlimCS are under development. The first design adopts the two directional beam scan mechanism that has proved good performance and reliability in JT-60U. The mechanism has one rotary focusing mirror at the end of the waveguide and one steerable flat mirror. It is important for this type of antenna to develop effective and reliable methods to drive and cool the mirror. In particular, in the vacuum vessel where remote maintenance is expected, water-leak free antenna should be used. As the second antenna design, therefore a new concept with a mirror driven in the linear motion [8] is proposed. The antenna eliminates the flexible tube for coolant supply and the link mechanism in the vacuum vessel as shown in Fig. 11, and will reduce the risk of water leakage or maintenance frequency. The performance of this type antenna has been studied assuming a dimension similar to JT-60U. A curved mirror having curvature radius of 0.7 m enables wide poloidal injection angle range of ~ 90 deg, assuming an upper inclined (~ 35 deg) port having relatively small cross section of $0.5 \text{ m} \times 0.5 \text{ m}$. The beam profile calculation [9] assuming distance between port mouse and resonance layer of 1.5 m, shows poloidal expansion due to the curved mirror for smaller poloidal injection angles as shown in Fig. 12, but relatively sharp profiles having Gaussian beam radius of 10 cm or less, comparable to the JT-60U antenna are obtained when the beam aims at off-axis plasma, $\sim +40$ deg in this example, where suppression of neoclassical tearing mode is expected.

In this antenna concept, there is a trade-off between the beam radius and the range of the poloidal beam angle scan as shown in Fig. 13. The curvature of the fixed curved mirror which determines the relation ship of these parameters should be chosen by the physics requirement or plan of the tokamak. The CAD image of the antenna preliminarily designed for JT-60SA having two waveguides is shown in Fig. 14. To reduce ohmic loss, surface of the mirror will be copper but the thickness of copper should be thin to reduce electromagnetic force on disruption and the copper plate will be attached on the base structure made of stainless steel with diffusion bonding technique. Rough estimation assuming $0.3 \text{ m} \times 0.1 \text{ m} \times 0.005 \text{ m}$ of copper plate, 5.5 MA, 0.01 s disruption and 2.7 T of toroidal magnetic field shows that the electromagnetic force to the second large curved mirror is

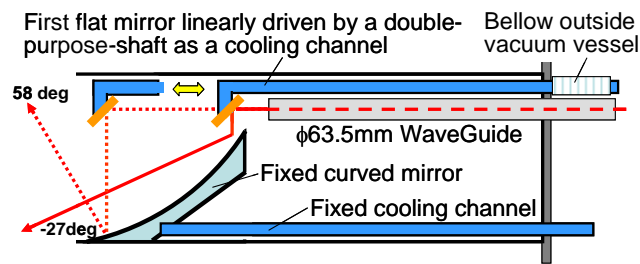

Fig. 11. Conceptual drawing of the antenna featuring a concept of “mirror driven in the linear motion”.

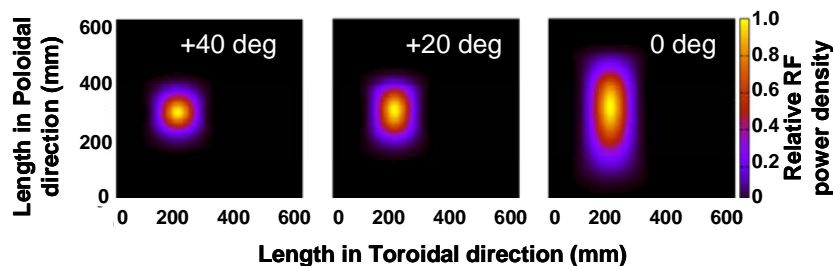

Fig. 12. Calculated beam power profiles at the typical poloidal injection angles.

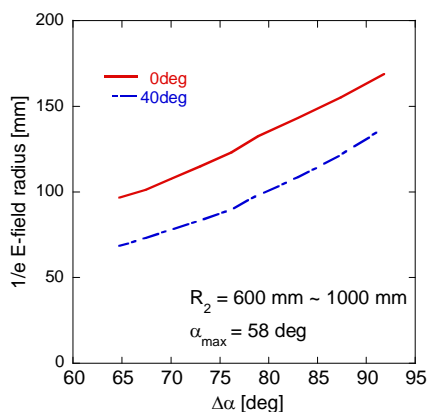

Fig. 13. Dependence of 1/e e-field radius on the range of poloidal beam angle.

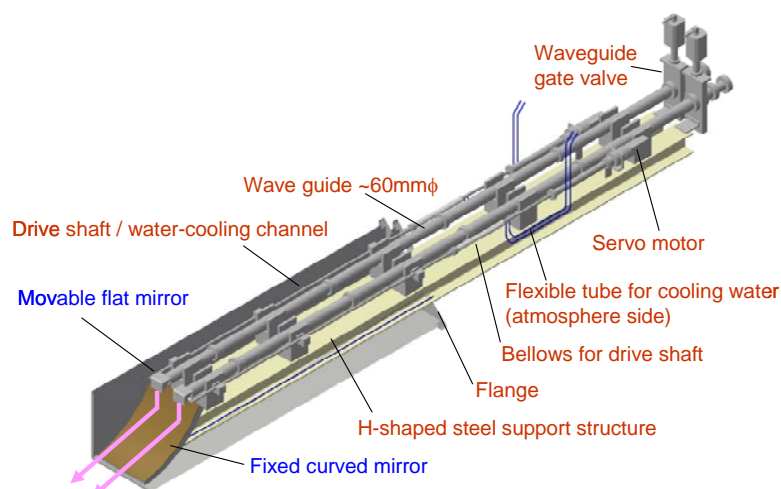

Fig. 14. Preliminary CAD model of the antenna for JT-60SA with reliable steering mirrors.

estimated to be 2 ton-f. It will be firmly fixed on the supporting structure with normal screw bolts having 10 mm diameter and 3.6 ton-f of stress resistance. The force on the first mirror having dimension of 0.08 m × 0.08 m is estimated to be similar level to the second mirror and the mirror will be firmly welded to the thick driving shaft.

6. Summary and outlook

The JT-60U ECRF system has completed its full operation in August of 2008. Operation of the system in the last two years was very fruitful. In the high power gyrotron development, 1.5 MW for 1s was recorded, and data of heat load in the gyrotron that are needed for further improvement have been obtained. Power modulation up to 7 kHz was achieved by improvement of anode modulation circuit. Using this technique, modulated and phase controlled ECCD at 5 kHz synchronizing with NTM was performed to investigate efficient NTM stabilization. Total power of 2.9 MW was injected to the plasma with 4 gyrotrons for 5sec, which is full specification of the system. As the long pulse development, the gyrotron, the transmission line, and the antenna shows reliable performance at 0.4 MW for 30 s using one gyrotron, though 0.35 MW, 45 s was achieved using three gyrotrons in sequential in 2004.

As a preparation for the JT-60SA project, development of the gyrotron with improved mode convertor aiming at 1 MW for 100 s oscillation has been started. Related development of transmission line and antenna components will also start in 2008.

Acknowledgement

The authors would like to express their appreciations to the members of JT-60 Team of JAEA for their continuous support and effort on the JT-60 experiments. They are grateful to Dr. Y. Tatematsu in university of Fukui for the numerical code of wave propagation on the antenna design.

References

- [1] K. Sakamoto *et al.*, Nucl. Fusion **43** (2003) 729.
- [2] Y. Ikeda *et al.*, Fusion Sci. Technol. **42** (2002) 435.
- [3] S. Moriyama *et al.*, Fusion Eng. Des. **74** (2005) 343.
- [4] T. Kobayashi *et al.*, Plasma and Fusion Res. **3** (2008) 014.
- [5] K. Sakamoto *et al.*, Nature Phys. **3** (2007) 411.
- [6] A. Isayama *et al.*, Fusion Energy 2008, EX/5-4
- [7] S. Moriyama *et al.*, Rev. Sci. Instrum. **76** (2005) 113504-1.
- [8] S. Moriyama *et al.*, Fusion Eng. Des. **82** (2007) 785.
- [9] Y. Tatematsu *et al.*, Jpn. J. of Appl. Phys. **44** (2005) 6791.